

Pressure Regulation for Earth Pressure Balance Control on Shield Tunneling Machine by Using Adaptive Robust Control

XIE Haibo, LIU Zhibin*, and YANG Huayong

State Key Laboratory of Fluid Power & Mechatronic Systems, Zhejiang University, Hangzhou 310027, China

Received October 15, 2015; revised January 9, 2016; accepted March 30, 2016

Abstract: Most current studies about shield tunneling machine focus on the construction safety and tunnel structure stability during the excavation. Behaviors of the machine itself are also studied, like some tracking control of the machine. Yet, few works concern about the hydraulic components, especially the pressure and flow rate regulation components. This research focuses on pressure control strategies by using proportional pressure relief valve, which is widely applied on typical shield tunneling machines. Modeling of a commercial pressure relief valve is done. The modeling centers on the main valve, because the dynamic performance is determined by the main valve. To validate such modeling, a frequency-experiment result of the pressure relief valve, whose bandwidth is about 3 Hz, is presented as comparison. The modeling and the frequency experimental result show that it is reasonable to regard the pressure relief valve as a second-order system with two low corner frequencies. PID control, dead band compensation control and adaptive robust control (ARC) are proposed and simulation results are presented. For the ARC, implements by using first order approximation and second order approximation are presented. The simulation results show that the second order approximation implement with ARC can track 4 Hz sine signal very well, and the two ARC simulation errors are within 0.2 MPa. Finally, experiment results of dead band compensation control and adaptive robust control are given. The results show that dead band compensation had about 30° phase lag and about 20% off of the amplitude attenuation. ARC is tracking with little phase lag and almost no amplitude attenuation. In this research, ARC has been tested on a pressure relief valve. It is able to improve the valve's dynamic performances greatly, and it is capable of the pressure control of shield machine excavation.

Keywords: shield tunneling machine, pressure regulation, adaptive robust control

1 Introduction

Shield tunneling machine is a complex underground construction machine which assembles navigation, excavation, segment installation. It has become the most popular approach for underground construction such as underground rail lines, submarine tunnels.

Fig. 1 shows a typical earth pressure balance shield tunnel machine and Fig. 2 shows a cross section of the machine, which presents detail structures insides. The machine mainly is composed of cutter head and its driving motors, thrust cylinders, screw conveyor and segment erector. Cutter head is equipped with ordinary cutters like roller cutters, scrapers and other specialized design cutters for complex stratum. Cutter head rotates and cuts off soil from stratum. The soil fills into the working chamber

behind the cutter head, and it is transferred out of the chamber by the screw conveyor later on. Thrust cylinders not only provide the thrust force but also control the machine posture. After every thrust stroke, segment erector, which works like a robotic hand, grabs up tunnel segments and locates these segments to corresponding positions. Segments are screwed and a new ring of tunnel is constructed.



Fig. 1. Shield tunneling machine

* Corresponding author. E-mail: lbaddie@zju.edu.cn

Supported by National Natural Science Funds of China (Grant No. 51275451), National Basic Research Program of China (973 Program, Grant No. 2013CB035404), Science Fund for Creative Research Groups of National Natural Science Foundation of China (Grant No. 51221004), and National Hi-tech Research and Development Program of China (863 Program, Grant No. 2013AA040203)

© Chinese Mechanical Engineering Society and Springer-Verlag Berlin Heidelberg 2016

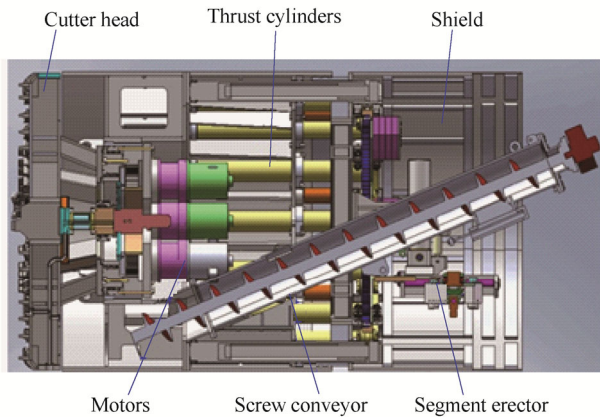

Fig. 2. Cross section of the machine

Earth pressure balance (EPB) should be guaranteed during the excavation process, otherwise some disaster consequences will happen. For example, tunnel or buildings will collapse if EPB is failed. Fig. 3 shows the concept of earth pressure balance control. Hydraulic thrust system provides thrust force for the excavation, and the thrust force has a direct effect on the earth pressure. Earth pressure balance is a condition that the pressures on both sides of excavation face are the same. On the stratum side, the pressure is composed of water pressure in the stratum and earth pressure. On the machine side, there is earth pressure in the working chamber. For the effect of gravity, pressures increase on vertical direction.

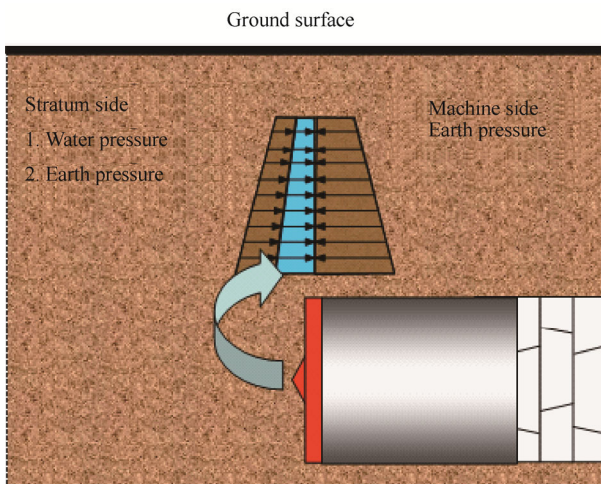

Fig. 3. Concept of earth pressure balance

ANAGNOSTOU, et al^[1], illustrated how the EPB control worked and presented a case study to support their opinions. BABENDERERDE, et al^[2], presented EPB control in complex hydro-geological conditions in a metro project. MAIDL^[3] studied the excavation by using EPB tunnelling machine in mixed face condition of soil and hard rock, and gave some solutions in such tough working conditions. LIU, et al^[4], presented the EPB control method by using least squares support vector machines and particle swarm optimization. PEILA, et al^[5], set up a test rig with working

chamber and screw conveyor to study how the conditioned soils worked during excavation. MAYNAR, et al^[6], built a discrete model to simulate the soil behaviours on the cutter head during excavation. The above-mentioned works focus on the earth pressure balance and the soil behaviours. Studies on the machine behaviours are also important. SUGIMOTO, et al^[7], built a dynamic model of the machine and gave a simulation to validate the proposed model. Afterwards, they also reported a site application to support the validation of their model in Ref. [8]. MANABE, et al^[9], proposed a linear quadratic regulator with Kalman filter to control the direction of a small pipeline shield machine. ZHU, et al^[10], did experiments to study the relationships between different working parameters. The mentioned works focus on the machine behaviours. But few works are concerned about the machine's regulation and the hydraulic system dynamics.

There are two approaches to control the earth pressure on the machine side. The first one is to adjust the rotational speed of screw conveyor. For example, if rotational speed increases, more soil in the working chamber will be conveyed out. And it will make the earth pressure decrease. SACZYNSKI^[11] applied such approach of earth pressure balance control and some monitoring data were given. Yet, the effect is not instantaneous. There is usually a time delay of about half a minute. The other way is to adjust the thrust force. This is an intuitive approach and is much more instantaneous than previous one. It is important to make a good adjustment of thrust force. It is not that easy, because the earth pressure, due to the disturbance of the cutter head motion, varies quickly on the excavation face. This requires the thrust force can be regulated quickly, which means the control element should have a good dynamic performance. Hydraulic cylinders are applied to generate thrust force. Thus, pressure control of these hydraulic cylinders is the same as the machine thrust force control.

Fig. 4 shows a hydraulic schematic of thrust system on the machine. The system is composed of a pressure compensation pump and four thrust groups. The circular distribution in Fig. 4 illustrates the assignment of the 32 thrust cylinders which are assigned to four groups. Each group has one regulation module, including units 2, 3 and 4, and some motion control modules, including units 5, 6 and 7, and corresponding thrust cylinders. The regulation module controls the thrust pressure or thrust speed. The motion control module controls the extension/stop/retraction motion of each pair of thrust cylinders. The pairs of cylinders are equipped with such motion control modules, individually. The key element of earth pressure balance control is unit 4, the proportional pressure relief valve. The thrust pressure is directly controlled by this pressure valve. Such valve, however, is not designed for high dynamic performance. Yet, it is possible to have some performance enhancements by using advanced closed loop control.

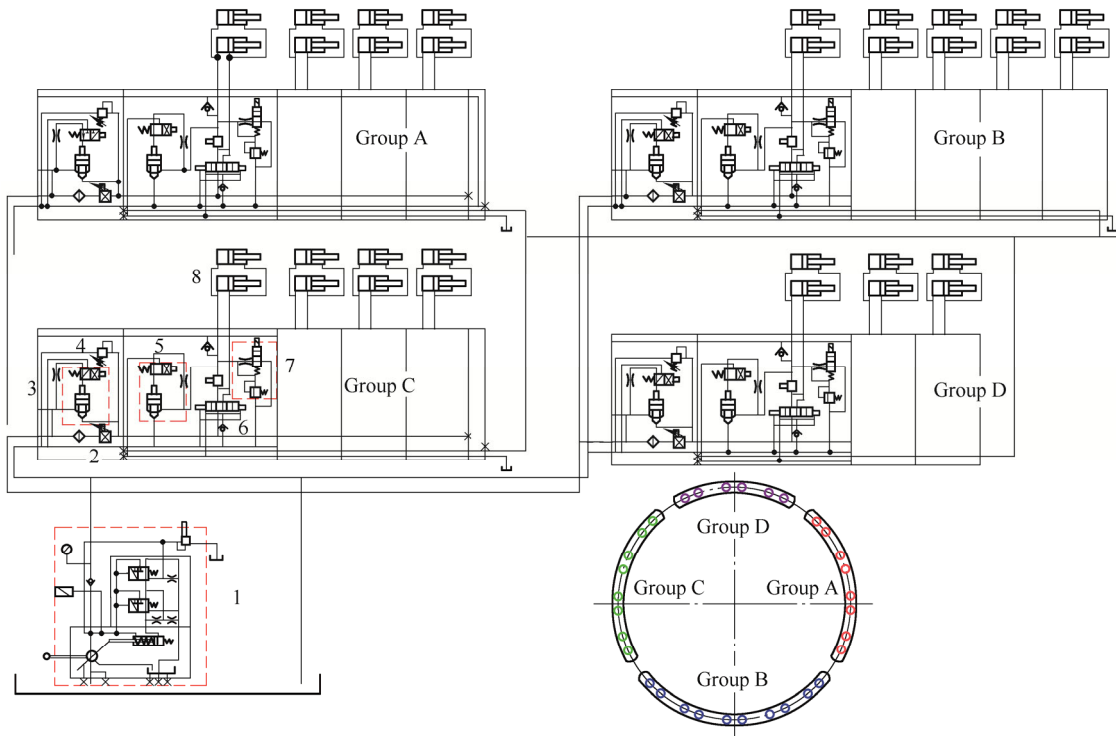

Fig. 4. Hydraulic schematic of thrust system

- 1. Pressure compensation pump; 2. Proportional flow control valve; 3. Fast extension valve; 4. Proportional pressure relief valve;
- 5. Fast retraction valve; 6. Directional control valve; 7. Safety block; 8. Thrust cylinders

Pressure control of hydraulic cylinder is a common scenario. TRUONG^[12] proposed a pump controlled cylinder system to achieve force control for hydraulic load simulator. One other approach is to control the flow rate into or out of a dynamic chamber. KILIC, et al^[13], worked on a pressure control with a 4-way servo-valve controlled piston. And such hardware set up is widely used in many applications like aeroplanes, steel mill casting. However, servo valves is expensive in cost and difficult to maintain when it brakes down. An economical approach is to apply proportional throttle valves to control those flow rates. OPDENBOSCH, et al^[14], applied four proportional throttle valves, which are called electro-hydraulic poppet valves in the paper, to achieve intelligent electronic pressure control on a cylinder. Another common approach in industry is to use a pressure control component to control the pressure. Proportional pressure relief valve and proportional pressure reducing valve are the two most popular components for the applications. A commercial shield tunnelling machine is usually equipped with these kinds of pressure control components to achieve thrust force control. YANG, et al^[15], gave a brief introduction and modelling for the electro-hydraulic thrust system on shield machine. XIE, et al^[16], set up a test rig for hydraulic thrust system and proportional pressure relief valves were applied. CHEN, et al^[17], set up a test platform for the electro-hydraulic system on shield machine, and pressure relief valves were used to control the thrust force.

Hoping to make a good application in site application, this work focuses on the pressure control of proportional pressure relief valve which is widely equipped on

commercial shield tunnelling machine.

2 Modeling of Pressure Relief Valve

In this research, a commercial proportional pressure relief valve, PMVP 5-44 from HAWE Co., is used as the regulation valve for the study. Fig. 5 shows the structure diagram of the PMVP 5-44 valve.

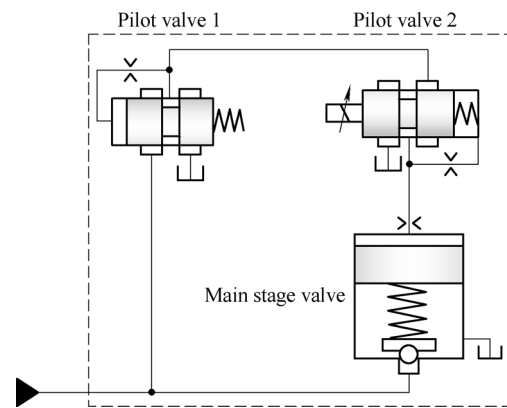

Fig. 5. Internal structure of the pressure relief valve

Pilot valve 1 is a 3-way pressure reducing valve, whose crack pressure is set to 2 MPa. Pilot valve 1 is used to pre-reduce the high pressure to obtain a constant pressure source for the pilot control oil line. Pilot valve 2 is a small size proportional pressure reducing valve, and the adjustment range is from 0 to 2 MPa. By going through a small orifice, the output pressure of pilot valve 2 exerts on the upper surface of the piston of the main stage valve.

The main stage is composed of a piston, a stiff spring and a ball valve. Hydraulic pressure force exerts on piston, then the stiff spring is compressed, thus the force is transferred to the ball valve. The ball valve is acting like a conventional pressure relief valve. The area proportion of piston versus ball valve acting area is about 22. Pressure in upper chamber of main stage valve is up to 2 MPa. And so, the highest pressure of the whole valve is over 40 MPa.

The aim is to enhance the pressure regulation dynamic performance by using such proportional valve. The dead band and amplifier gain are assumed unknown but their bounds are known. Bandwidths of commercial pilot pressure relief valves are usually around 5 Hz, not exceeding 10 Hz at most. Note that bandwidths of pilot valves, which can be up to 50 Hz or even more, are higher than that of the whole valve. Thus the dynamic performance mainly depends on two factors. One is the main stage valve and the other is the system chamber

dynamics, which is not determined by the valve. The modelling focuses on the main stage valve, as shown in Fig. 6. Notations used in the paper are defined as Table 1.

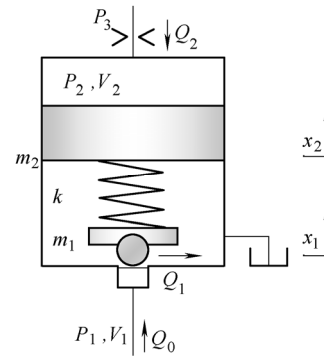

Fig. 6. Modeling of the main stage of pressure relief vae

Table 1. Notations in modeling

Symbol	Physical quantitie	Symbol	Physical quantitie
m_1	Mass of ball valve	k	Spring stiffness
m_2	Mass of piston	V_1	System chamber volume
x_1	Position of ball valve	V_2	Piston chamber volume
x_2	Position of piston	A_1	Active area of ball valve
\dot{x}_1	Velocity of ball valve	A_2	Active area of piston
\dot{x}_2	Velocity of piston	P_1	Pressure in system chamber
\ddot{x}_1	Acceleration of ball valve	P_2	Pressure in upper piston chamber
\ddot{x}_2	Acceleration of piston	P_3	Pressure of the control input
b_1	coefficient of viscous friction on ball valve	β	Bulk modulus of hydraulic oil
b_2	coefficient of viscous friction on piston	Q_1	Flow rate through ball valve
f_1	Friction force on ball valve	Q_2	Flow rate through orifice
f_2	Friction force on piston	Q_0	Flow rate from system

Ball valve is acted on by hydraulic force, spring force, vicious force, friction force and hydraulic flow force. The piston is acted on by the same types of forces as those on ball valve but the hydraulic flow force, because hydraulic flow force acts only on the valve when hydraulic oil is flowing through. By applying the Newton's second law, dynamic equations of ball valve and piston can be derived as follows:

$$m_1 \ddot{x}_1 = P_1 A_1 - k(x_1 - x_2) - b_1 \dot{x}_1 - \text{sgn}(\dot{x}_1) \cdot f_1 - F_{h1}(P_1, Q_1), \quad (1)$$

$$m_2 \ddot{x}_2 = -P_2 A_2 + k(x_1 - x_2) - b_2 \dot{x}_2 - \text{sgn}(\dot{x}_2) \cdot f_2. \quad (2)$$

The chamber dynamic equations are as follows:

$$\frac{V_1}{\beta} \dot{P}_1 = Q_0 - Q_1, \quad (3)$$

$$\frac{V_2 + A_2 x_2}{\beta} \dot{P}_2 = Q_2 + A_2 \dot{x}_2. \quad (4)$$

system chamber dynamics is determined by the chamber volume V_1 , which is variable, and the flow rate difference. The tiny volume change caused by ball valve position change is ignored here, because the position difference is less than 1mm, usually hundreds of micro-meters. The piston chamber dynamics is determined by its changing chamber volume and flow rate through the orifice. Flow rate equations for orifice and ball valve are as follows:

$$Q_1 = G_1 \cdot P_1^{\frac{1}{2}}, \quad (5)$$

$$Q_2 = G_2 (P_3 - P_2)^{\frac{1}{2}}. \quad (6)$$

Obviously, such main stage valve is a sixth order system which is difficult to derive a practical model for control design. By backstepping design^[18], the problem can be solved theoretically, yet some assumptions have to be achieved. For example, it is not easy but required to generate a sixth-order derivative control signal; otherwise discontinuous design should be introduced to solve such problem, which makes the problem more complicated. It is also not easy to measure all the state variables, such as

By considering the oil bulk modulus as constant, the

the tiny ball valve displacement. Actually, the only variables can be measured on a commercial valve are the input signal and the output pressure. And those valve displacements or the pressures in the valve chambers can not be measured.

In order to derive a practical model, a simulation model of the valve was established. Parameters were set as Table 2.

Table 2. Parameters of valve

Parameter	Value
m_1/g	5
m_2/g	78
$k/(r \cdot \text{min}^{-1})$	170
V_1/cm^3	2000
V_2/cm^3	0.49
A_1/mm^2	22.9
A_2/mm^2	491
β/MPa	1400
$b_1/(\text{N} \cdot \text{s} \cdot \text{m}^{-1})$	0.1
$b_2/(\text{N} \cdot \text{s} \cdot \text{m}^{-1})$	4
f_1/N	0
f_2/N	1
$Q_0/(\text{L} \cdot \text{min}^{-1})$	30

Simulation of mode analysis shows that there are two first-order modes and two oscillation modes. Considering the two first-order modes, one corner frequency is 2.45 Hz and the other is 9.82 Hz. The 2.45 Hz frequency is determined by piston chamber dynamics and the 9.82 Hz is determined by system chamber dynamics. And there are two oscillation modes of 1.31 kHz and 11.4 kHz, one is the piston mass-spring system oscillation and the other is ball valve mass-spring system oscillation. Through the simulation result, the proportional pressure relief valve system can be regarded as a second-order system with two low corner frequencies.

To validate such results, a frequency test was done. The valve regulation pressure was set to oscillate around 10 MPa, with sine input varied from 0.15 Hz to 10 Hz. The magnitudes were recorded. The bode graphs of experiment results and simulation results are shown in Fig. 7. The comparison shows the simulation has a good agreement with the actual valve dynamics.

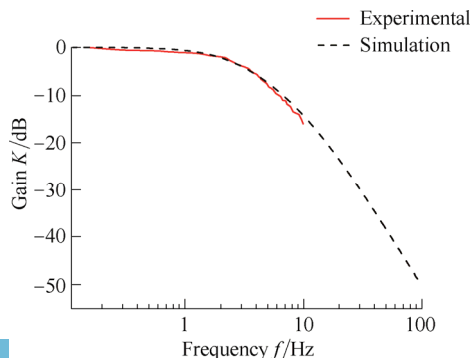

Fig. 7. Bode graphs of experimental results and simulation

3 Controller Design

As known to all, there is a dead band in the proportional pressure relief valve. The dead band is usually from 10% to 20% of the maximum input. To compensate such dead band, industrial approach is to composite a step signal to the control signal, which is also known as inversed dead band compensation. This approach is usually integrated into a commercial amplifier, and the signal amplitude can be adjusted to achieve a suitable compensation. It works very well if perfect compensation is made, but the perfect compensation is difficult in reality.

Another common industrial approach is the well-known PID controller. It is suitable for such valve control because the integer item can compensate the dead band effect and the differential item has a good performance in dynamic tracking. However, PID controller is a kind of feedback control based on error dynamics, which means the output pressure will always go behind the desired signal.

In this research, adaptive robust control (ARC) is proposed to solve the problem. The ARC is proposed by YAO. Systemic theory was presented in Refs. [19] and [20], and some experiment studies based on machine tool setup were reported in Ref. [21]. Some applications of ARC on hydraulic single rod and double rod motion controls driven by servo valves were reported^[22-23]. ARC on proportional valve control application, which can reduce the cost of system setup, was reported and the experiment results showed good dynamic performances^[24]. ARC has good dynamic performances and is capable of application on hydraulic system. The ARC diagram is shown as Fig. 8.

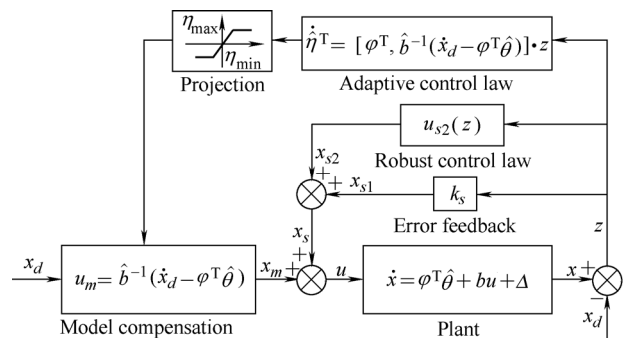

Fig. 8. Diagram of adaptive robust control

- x — State variables,
- ϕ — System parameters,
- θ — Expected reachable angle around axis,
- b — Input parameters,
- u — Input signal,
- x_d — Desired values,
- z — $x - x_d$, tracking error,
- $\hat{\theta}$ — Estimated values,
- $\tilde{\theta} = \hat{\theta} - \theta$, estimation error,
- $\dot{\hat{\theta}}$ — Derivative of estimated values,
- Δ — Model uncertainties.

Compared with robust control theory, ARC is a combination of adaptive control and robust control. The

very first design came from the traditional adaptive control. If there is no model structure error and there only exist parameter estimated errors, the adaptive control can do a good control without the robust item. But in reality, there are always some model structure errors, like some nonlinear factors which can not be formulated exactly. So if the model structure errors or parameter uncertainties are notable, robust control is introduced and dominates the control output and also enhances the dynamic performances. There is no contradiction between robust control and ARC. Robust control design theory also works in ARC design procedure. Proof of ARC stability is different from Kharitonov interval theory. The proof is based on Lyapunov stability theory. The robust item in ARC is more or less like H_∞ control. The design is to find out the bounds of those uncertainties. The ARC design procedure combined with structure singular value theory has not been reported yet, which can be done in future.

State-space equation is used to describe the plant. The model compensation block is applied as a feed forward controller. The adaptive feedback, designed according to Lyapunov stability theory, adjusts the model parameters and makes error converge to zero asymptotically. There are some modelling errors, disturbances and noise in the process. All these uncertain factors are lumped as item Δ . To overcome the effect of model uncertainties, robust control item is introduced and it guarantees a good dynamic performance.

Controller is designed as follows.

Controller output:

$$u = u_m + u_{s1} + u_{s2}. \quad (7)$$

Model compensation:

$$u_m = \hat{b}^{-1}(\dot{x}_d - \phi^T \hat{\theta}). \quad (8)$$

Stability feedback:

$$u_{s1} = k_s \cdot z. \quad (9)$$

Robust feedback:

$$u_{s2} = -\text{sgn}(z) \times [|\phi^T| \times (\eta_{\max} - \eta_{\min}) + |\Delta|_{\max}]. \quad (10)$$

Parameter adaptation law:

$$\dot{\hat{\eta}} = \phi \cdot z. \quad (11)$$

Where $\eta^T = [\theta^T, b]$ and $\phi^T = [\phi^T, \hat{b}^{-1}(\dot{x}_d - \phi^T \hat{\theta})]$. They are the augmented vectors for system parameters and known functions respectively.

4 Sine Tracking Simulations

When the bandwidth of dynamic signal is low enough, a

first order model approximation can be used as the dynamic model so as to simply the problem. While the signal is higher, second order model approximation should be applied to achieve better performance. Simulations of first order model approximation and second order model approximation were done. Inversed dead band compensation, PID controller and ARC were applied to these simulations to demonstrate the performance differences.

Implement of the 1st order approximation is shown as follows.

The 1st order model is formulated as

$$G_1(s) = \frac{\Delta P}{\Delta u} = \frac{K}{s/\omega_1 + 1}. \quad (12)$$

Taking dead band into consideration, notified as a , dynamic equation can be derived as follows:

$$\dot{P} = -\omega_1 P + K\omega_1(u - a). \quad (13)$$

And the vector form for the equation is

$$\dot{P} = [-P \quad -1] \cdot [\omega_1 \quad K\omega_1 a]^T + K\omega_1 u. \quad (14)$$

Hence corresponding symbols in the ARC diagram are set as below:

$$\begin{cases} x_d = P_d, \\ \varphi = [-P \quad -1]^T, \\ \theta = [\omega_1 \quad K\omega_1 a]^T, \\ b = K\omega_1, \\ \eta = [\omega_1 \quad K\omega_1 a \quad K\omega_1]^T, \\ \phi = [-P \quad -1 \quad \hat{b}^{-1}(\dot{P}_d + \omega_1 P + K\omega_1 a)]^T. \end{cases} \quad (15)$$

Implement of the 2nd order approximation is similar to that of the 1st order approximation:

$$G_2(s) = \frac{\Delta P}{\Delta u} = \frac{K}{(s/\omega_1 + 1)(s/\omega_2 + 1)}. \quad (16)$$

Taking dead band into consideration, dynamic equation can be derived as follows:

$$\ddot{P} = -(\omega_1 + \omega_2)\dot{P} - \omega_1\omega_2 P - K\omega_1\omega_2 a + K\omega_1\omega_2 u. \quad (17)$$

Then vector form for the equation is given.

$$\begin{aligned} \ddot{P} &= [-\dot{P} \quad -P \quad -1] \cdot \\ &[\omega_1 + \omega_2 \quad \omega_1\omega_2 \quad K\omega_1\omega_2 a]^T + K\omega_1\omega_2 u. \end{aligned} \quad (18)$$

Corresponding symbols in the ARC diagram are set as below,

$$\begin{cases} x_d = P_d, \\ \varphi = [-\dot{P} \quad -P \quad -1]^T, \\ \theta = [\omega_1 + \omega_2 \quad \omega_1\omega_2 \quad K\omega_1\omega_2 a]^T, \\ b = K\omega_1\omega_2, \\ \eta = [\omega_1 + \omega_2 \quad \omega_1\omega_2 \quad K\omega_1\omega_2 a \quad K\omega_1\omega_2]^T, \\ \phi = [-\dot{P} \quad -P \quad -1 \\ \hat{b}^{-1}(\ddot{P}_d + (\omega_1 + \omega_2)\dot{P} + \omega_1\omega_2 P + K\omega_1\omega_2 a)]^T. \end{cases} \quad (19)$$

The plant is given as

$$G(s) = \frac{K}{(s/\omega_a + 1)(s/\omega_b + 1)}, \quad (20)$$

where $K = 3.3$, $\omega_a = 6\pi$, $\omega_b = 16\pi$, and input dead band is set to 14% of the maximum input signal.

The inverted compensation controller is set to achieve perfect compensation. The PID controller is set to proportional gain of 3 and integer gain of 0.6.

For the 1st model approximation, parameters are set as follows.

Stability feedback gain: $K_s = -2$.

Initial values of parameters: $\hat{K}_0 = 3$, $\hat{\omega}_{10} = 15$, $\hat{a}_0 = 1$.

Adaptation gains for parameter estimation are set to 0.04.

Desired pressure is $10 + \sin(2\pi t)$ MPa. And the control performances are shown as Fig. 9, errors are shown as Fig. 10.

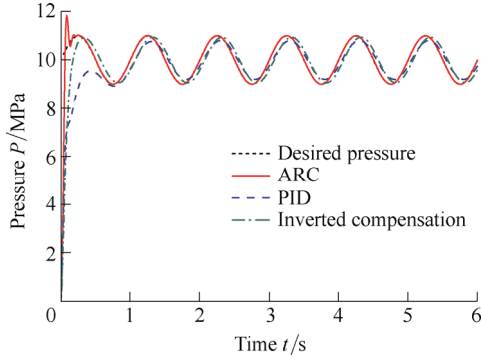

Fig. 9. 1 Hz sine tracking of the three controllers

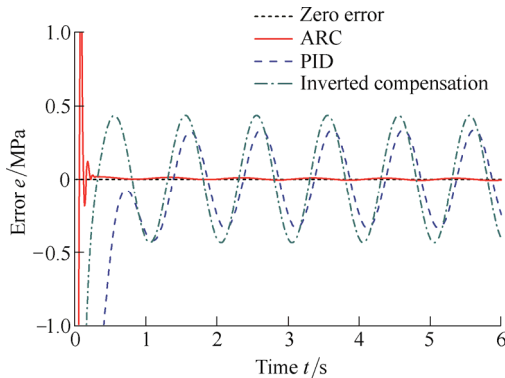

Fig. 10. Tracking errors of the three controllers

All three controllers perform well if phase offset is neglected. Looking into the error figures, ARC has the best tracking performance.

Then the desired pressure is $10 + \sin(8\pi t)$ MPa, which is

4 times as high in frequency as the previous setting, and performances are shown as Fig. 11 and Fig. 12.

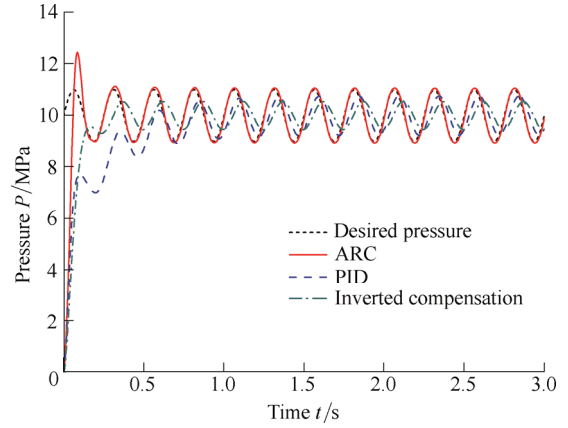

Fig. 11. 4 Hz sine tracking of the three controllers

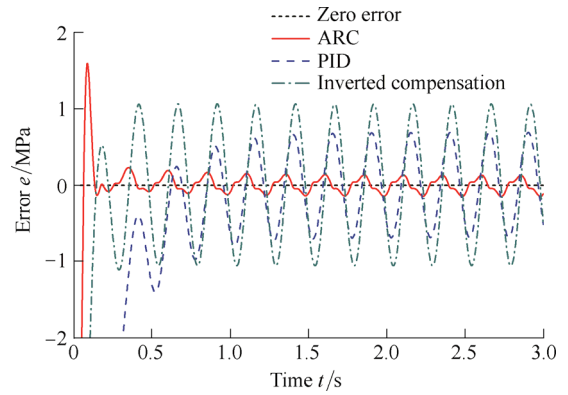

Fig. 12. Tracking errors of the three controllers

Obviously, ARC still has a good performance while PID and inverted compensation controller cannot make good tracking controls. Error amplitude of the PID is about 0.7 MPa and error amplitude of inverted compensation controller is 1 MPa. The ARC tracking error amplitude is less than 0.2 MPa.

If better tracking is required for higher frequency signal, the 2nd order approximation should be applied. For the 2nd model approximation, parameters are set as follows.

Stability feedback gain: $K_s = -2$.

Initial values of parameters: $\hat{K}_0 = 3$, $\hat{\omega}_{10} = 15$, $\hat{\omega}_{20} = 60$, $\hat{a}_0 = 1$.

Adaptation gains for parameter estimation are set to 0.02.

Desired pressure is also $10 + \sin(8\pi t)$. The comparison results are shown as Fig. 13 and Fig. 14.

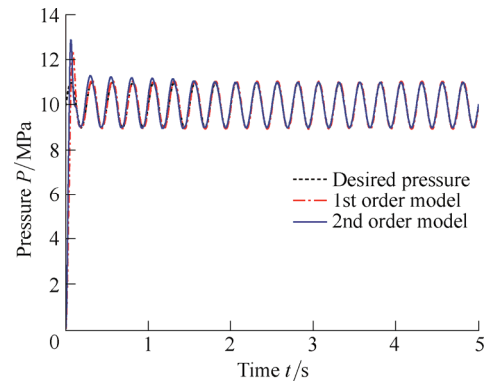

Fig. 13. 4 Hz sine tracking of the 1st and 2nd order models

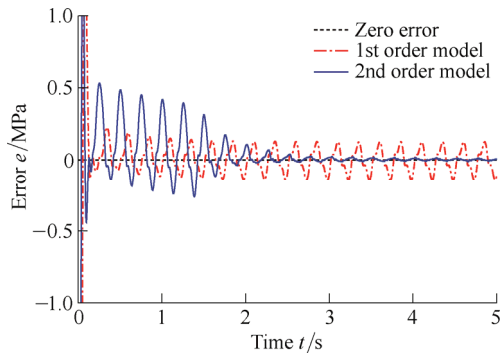

Fig. 14. Tracking errors of the 1st and 2nd order models

Both controllers have good performances. Looking into error comparison, the 2nd order approximation ARC controller works better. The amplitude error can be controlled as small as 0.05 MPa.

5 Sine Tracking Experiments

The experiment device is shown as Fig. 15. The device is composed of a regulation module and a motion control module, as introduced in Fig. 4 the hydraulic schematic. The experiments were done on a HAWE's PMVP 44-5 proportional pressure relief valve. The I/O device was an Advantech's data acquisition board PCI 1710, and control unit was an industrial PC. Time interval was set as 10ms. Hydraulic oil supply was 30 L/min. Control volume was approximately 2 L. Pressure was measured by a pressure gauge ranged up to 40 MPa and its resolution was 0.1%. The sensor's signal was converted to 1–5 V analog signal, corresponding to 0–40 MPa.

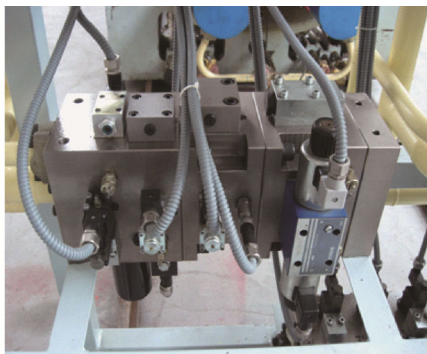

Fig. 15. Experimental device of pressure regulation

The first order approximation controller was applied to the experiments, for it was easier to implement. And what was more important, the second order approximation required second-order differential of pressure signal, and that was not easy to acquire because of the noise. The parameters were set the same as those in the simulation. The tracking signal was a 1 Hz sine signal with amplitude of 1 MPa. For the hardware delay, the sine signal is about 0.75 Hz, slightly lower, in the ARC experiment. But it will not affect much on the comparison study. The desired signal was set to 10 MPa at beginning, and the sine signal was given afterwards. According to simulation studies, the

dead band compensation control has similar performances as the PID control. And the dead band compensation control for proportional valve is the most popular approach in such industrial hydraulic application. To have a comparison, dead band compensation experiment was done.

The experiment results agreed with the simulations. There were phase lag and amplitude attenuation in dead band compensation control experiment. As shown in Fig. 16, the phase lag was about 30° . There were also some errors in constant 10 MPa regulation. That is because the compensation was a little under-compensated. Perfect compensation is not easy to achieve all the time in applications. The adaptive robust control had a good tracking performance of dynamic signal, as shown in Fig. 17. After parameters adaptive regulation, the constant 10 MPa regulation was almost zero steady state error. Thanks to the model compensation, there was little phase lag in ARC. Overall, the control pressure was almost the same as desired value.

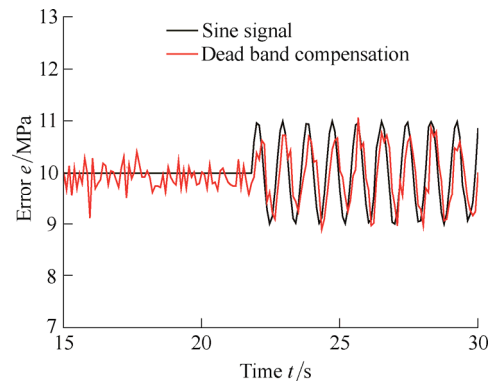

Fig. 16. Experiment of dead band compensation

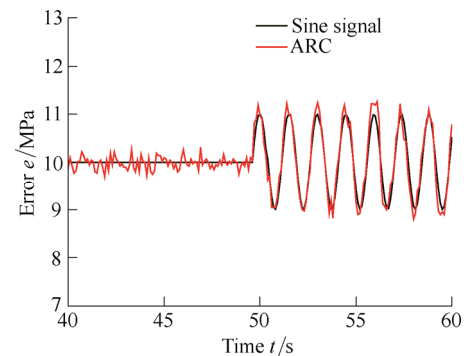

Fig. 17. Experiment of adaptive robust control

6 Conclusions

(1) To obtain a better dynamic earth balance control, adaptive robust controller was applied to implement the pressure control. A good benefit is that accuracy modeling and structure parameters are not necessary. And this will make the controller much easier to implement on site.

(2) The two low corner frequencies, one is determined by the main stage valve's dynamics and the other is determined by the system volume dynamics, are the

primary factors in the pressure relief valve's frequency response.

(3) ARC implements of first and second order approximations were proposed. Simulations and experiments of sine signal tracking control were done. The results showed such adaptive robust controller performed much better than industrial approaches did.

References

- [1] ANAGNOSTOU G, KOVARI K. Face stability conditions with earth-pressure-balanced shields[J]. *Tunnelling and Underground Space Technology*, 1996, 11(2): 165–173.
- [2] BABENDERERDE S, HOEK E, MARINOS P G, et al. EPB-TBM face support control in the Metro do Porto project, Portugal[C]// *Proceedings 2005 Rapid Excavation & Tunneling Conference*, Seattle, USA, 2005: 1–12.
- [3] MAIDL U. Geotechnical and mechanical interactions using the earth-pressure balanced shield technology in difficult mixed face and hard rock conditions[C]// *Proceedings of the 31st ITA-AITES World Tunnel Congress*, Istanbul, Turkey, 7–12 May, 2005: 723–728.
- [4] LIU Xuanyu, SHAO Cheng, MA Haifeng, et al. Optimal earth pressure balance control for shield tunneling based on LS-SVM and PSO[J]. *Automation in Construction*, 2011, 20(4): 321–327.
- [5] PEILA D, OGGERI C, VINAI R. Screw conveyor device for laboratory tests on conditioned soil for EPB tunneling operations[J]. *Journal of Geotechnical and Geoenvironmental Engineering*, 2007, 133(12): 1622–1625.
- [6] MAYNAR M J M, RODRIGUEZ L E M. Discrete numerical model for analysis of earth pressure balance tunnel excavation[J]. *Journal of Geotechnical and Geoenvironmental Engineering*, 2005, 131(10): 1234–1242.
- [7] SUGIMOTO M, SRAMOON A. Theoretical model of shield behavior during excavation. I: Theory[J]. *Journal of Geotechnical and Geoenvironmental Engineering*, 2002, 128(2): 138–155.
- [8] SRAMOON A, SUGIMOTO M, KAYUKAWA K. Theoretical model of shield behavior during excavation. II: Application[J]. *Journal of Geotechnical and Geoenvironmental Engineering*, 2002, 128(2): 156–165.
- [9] MANABE T, TANNO M, MATSUMOTO M, et al. Automatic direction control technique for microtunneling machine[C]// *Industrial Electronics Society, 1999. IECON '99 Proceedings*, San Jose, CA, USA, 29 Nov–3 Dec, 1999: 1295–1300.
- [10] ZHU Hehua, XU Qianwei, ZHENG Qizhen, LIAO Shaoming. Experimental study on the working parameters of EPB shield Tunneling in soft ground[J]. *China Civil Engineering Journal*, 2007, 29(12): 1849–1857. (in Chinese)
- [11] SACZYNSKI T M, PEARCE M, ELIOFF A. Monitoring Earth Pressure Balance Tunnels in Los Angeles[C]// *Seventh International Symposium on Field Measurements in Geomechanics*, Boston, MA, USA, Sept. 24–27, 2007: 1–12.
- [12] TRUONG D Q, AHN K K. Force control for hydraulic load simulator using self-tuning grey predictor-fuzzy PID[J]. *Mechatronics*, 2009, 19(2): 233–246.
- [13] KILIC E, DOLEN M, KOKU A B, et al. Accurate pressure prediction of a servo-valve controlled hydraulic system[J]. *Mechatronics*, 2012, 22(7): 997–1014.
- [14] OPDENBOSCH P, SADEGH N, BOOK W. Intelligent controls for electro-hydraulic poppet valves[J]. *Control Engineering Practice*, 2013, 21(6): 789–796.
- [15] YANG Huayong, SHI Hu, GONG Guofang, et al. Electro-hydraulic proportional control of thrust system for shield tunneling machine[J]. *Automation in Construction*, 2009, 18(7): 950–956.
- [16] XIE Haibo, DUAN Xiaoming, YANG Huayong, et al. Automatic trajectory tracking control of shield tunneling machine under complex stratum working condition[J]. *Tunnelling and Underground Space Technology*, 2012, 32: 87–97.
- [17] CHEN Kui, WANG Haixia. The electro-hydraulic control system design of shield test platform[C]// *2012 International Conference on Measurement, Information and Control (MIC)*, Harbin, China, 18–20 May, 2012: 900–906.
- [18] KRSTIC M, KANELLAKOPOULOS I, KOKOTOVIC P V. *Nonlinear and adaptive control design*[M]. New York: John Wiley & Sons, Inc., 1995.
- [19] YAO Bin. High performance adaptive robust control of nonlinear systems: A general framework and new schemes[C]// *Proc. of the 36th IEEE Decision and Control*, San Diego, CA, USA, 10–12 Dec, 1997: 2489–2494.
- [20] YAO Bin, TOMIZUKA M. Adaptive robust control of SISO nonlinear systems in a semi-strict feedback form[J]. *Automatica*, 1997, 33(5): 893–903.
- [21] YAO Bin, MAJED M A, TOMIZUKA M. High-performance robust motion control of machine tools: An adaptive robust control approach and comparative experiments[J]. *IEEE/ASME Transaction on Mechatronics*, 1997, 2(2): 63–76.
- [22] YAO Bin, BU Fangping, REEDY J T, et al. Adaptive robust control of single-rod hydraulic actuators: Theory and Experiments[J]. *IEEE/ASME Transactions on Mechatronics*, 2000, 5(1): 79–91.
- [23] YAO Bin, BU Fangping, CHIU G C T. Nonlinear adaptive robust control of electro-hydraulic systems driven by double-rod actuators[J]. *International Journal of Control*, 2001, 74(8): 761–775.
- [24] MOHANTY A, YAO Bin. Integrated direct/indirect adaptive robust control of hydraulic manipulators with valve deadband[J]. *IEEE/ASME Transactions on Mechatronics*, 2011, 16(4): 707–715.

Biographical notes

XIE Haibo, born in 1975, received his PhD degree from *Zhejiang University, China*, in 2004, and now works as an associate professor at *State Key Laboratory of Fluid Power & Mechatronic Systems, Zhejiang University, China*. His current research interests include mobile hydraulic control systems and components, tunneling boring machine driving technique.
E-mail: hbxie@zju.edu.cn

LIU Zhibin, born in 1985, is currently a PhD candidate at *State Key Laboratory of Fluid Power & Mechatronic Systems, Zhejiang University, China*. His current research interests include electro-hydraulic system on shield tunneling machine.
E-mail: lbaddie@zju.edu.cn

YANG Huayong received his PhD degree from *Bath University, UK*, in 1988, and now works as a professor at *State Key Laboratory of Fluid Power & Mechatronic Systems, Zhejiang University, China*. His current research interests include motion control, energy saving of mechatronic systems, fluid power component and system development.
E-mail: yhy@zju.edu.cn

Reproduced with permission of copyright owner. Further reproduction prohibited without permission.